



Datenblatt - Fiche technique - Data sheet

21.15.2970



ROLINE Patchkabel Kat.6A S/FTP (PiMF), Comp. Level, LSOH, grau, 0,3 m

Cordon ROLINE S/FTP(PiMF) Cat.6A / 10 Gigabit, LSOH, Component Level, gris,
0,3 m

ROLINE S/FTP Patch Cord Cat.6A, Component Level, LSOH, grey, 0.3 m

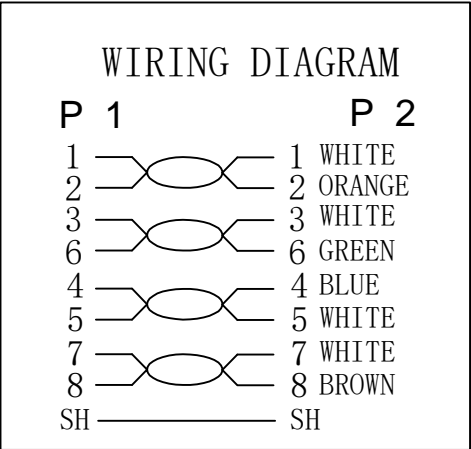
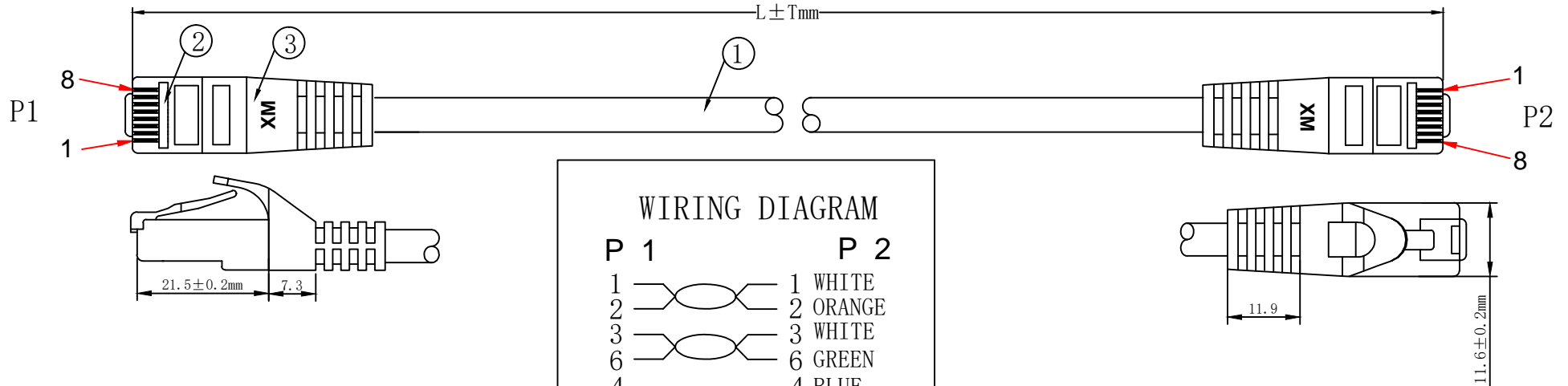

1. ELECTRICAL TEST:

- (1).100% OPEN SHORT & MISS WIRE TEST;
- (2).INSULATION RESISTANCE:DC 250V 20M OHM MIN;
- (3).CONTACTOR RESISTANCE:30 OHM MAX

2.PRINTING:GHMT® roline CAT.6A S/FTP COMPONENT PATCH CORD LSZH 500MHZ ISO/IEC 11801 & EN 50173-1 & ANSI/TIA-568-C.2

3.100% Component Patch cord Test PASS

4.Minimum bending radius:60mm

MATERIAL LIST

⑥	LABEL	NO DRY GLUE LABEL	1PCS	
⑤	MINI TIE	PE MINI TIE(POSSESS METAL)	2PCS	
④	POLYETHYLENE BAG	POLYETHYLENE BAG	1PCS	
③	OVER MOLD	88A PVC Grey	2PCS	
②	CONNECTOR	RJ45 8P8C'S SHIELDED PIN GOLD PLATED 3u", SHELL PLATED NICKEL Transparent Blue	2PCS	
①	CABLE	S/FTP CAT.6A 26AWG (BC*1P+AL-FOIL)*4P+BRAID CABLE JACKET LSOH OD=6.2±0.2MM	1PCS	
NO.	PARTS NAME	SPECIFICATION STANDARD	QT' Y	REMARK

COLOUR:GRAY(RAL 7035)

ITEM NO.	LENGTH(L)	TOLERANCE(T)
21.15.2970	300mm	±10mm
21.15.2800	500mm	±15mm
21.15.2801	1000mm	±30mm
21.15.2804	1500mm	±45mm
21.15.2802	2000mm	±60mm
21.15.2803	3000mm	±90mm
21.15.2805	5000mm	±150mm
21.15.2806	7000mm	±210mm
21.15.2807	10000mm	±300mm
21.15.2808	15000mm	±450mm
21.15.2809	20000mm	±600mm

ITEM NO.	21.15.2970	21.15.2800	21.15.2801	21.15.2802	21.15.2803
21.15.2804	21.15.2805	21.15.2806	21.15.2807	21.15.2808	21.15.2809
DESC.	ROLINE S/FTP PatchCord CAT.6A, LSOH, Comp.Level1, grey				

ARVIN	ALVAN	CHANGE COLOR GREY	2016-11-28	A1
		NEW	2016-09-13	A
BY	CHK	REVISION RECORD MODIFICATIONS	DATE	REV.

SECOMP