



Datenblatt - Fiche technique - Data sheet

21.15.2866



ROLINE Patchkabel Kat.6A S/FTP (PiMF), Comp. Level, LSOH, weiss, 7,5 m

Cordon ROLINE S/FTP(PiMF) Cat.6A / 10 Gigabit, LSOH, Component Level,
blanc, 7,5 m

ROLINE S/FTP Patch Cord Cat.6A, Component Level, LSOH, white, 7.5 m

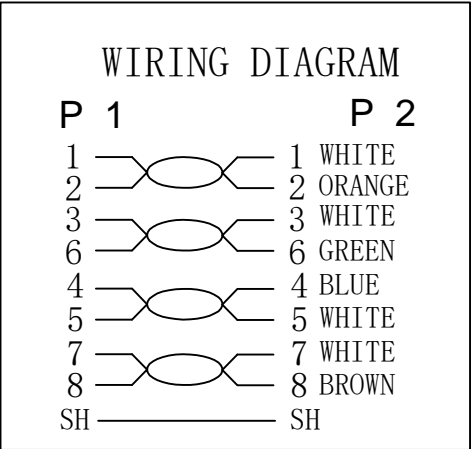
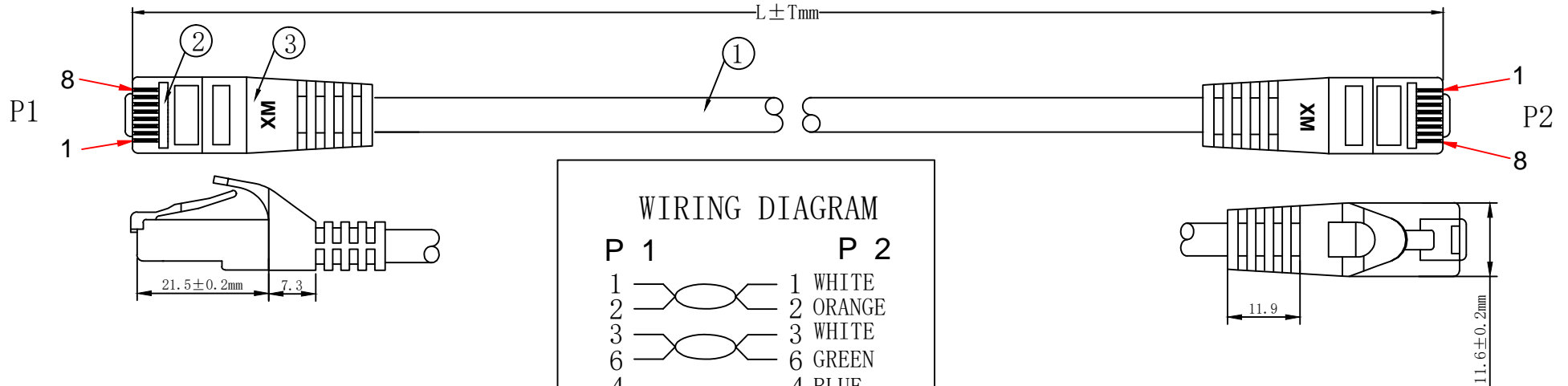

1. ELECTRICAL TEST:

- (1).100% OPEN SHORT & MISS WIRE TEST;
- (2).INSULATION RESISTANCE:DC 250V 20M OHM MIN;
- (3).CONTACTOR RESISTANCE:30 OHM MAX

2.PRINTING:GHMT® roline CAT.6A S/FTP COMPONENT PATCH CORD LSZH 500MHZ ISO/IEC 11801 & EN 50173-1 & ANSI/TIA-568-C.2

3.100% Component Patch cord Test PASS

4.Minimum bending radius:60mm

MATERIAL LIST

⑥	LABEL	NO DRY GLUE LABEL	1PCS	
⑤	MINI TIE	PE MINI TIE(POSSESS METAL)	2PCS	
④	POLYETHYLENE BAG	POLYETHYLENE BAG	1PCS	
③	OVER MOLD	88A PVC White	2PCS	
②	CONNECTOR	RJ45 8P8C'S SHIELDED PIN GOLD PLATED 3u", SHELL PLATED NICKEL Transparent Blue	2PCS	
①	CABLE	S/FTP CAT.6A 26AWG (BC*1P+AL-FOIL)*4P+BRAID CABLE JACKET LSOH OD=6.2±0.2MM	1PCS	
NO.	PARTS NAME	SPECIFICATION STANDARD	QT' Y	REMARK

COLOUR:White

ITEM NO.	LENGTH(L)	TOLERANCE(T)
21.15.2976	300mm	±10mm
21.15.2860	500mm	±15mm
21.15.2861	1000mm	±30mm
21.15.2864	1500mm	±45mm
21.15.2862	2000mm	±60mm
21.15.2863	3000mm	±90mm
21.15.2865	5000mm	±150mm
21.15.2866	7500mm	±210mm
21.15.2867	10000mm	±300mm
21.15.2868	15000mm	±450mm
21.15.2869	20000mm	±600mm

ITEM NO.	21.15.2976	21.15.2860	21.15.2861	21.15.2862	21.15.2863
21.15.2864	21.15.2865	21.15.2866	21.15.2867	21.15.2868	21.15.2869
DESC.	ROLINE S/FTP PatchCord CAT.6A, LSOH, Comp.Level,White				

SECOMP

BY	CHK	NEW	2016-09-13	A
		REVISION RECORD MODIFICATIONS	DATE	REV.