



Datenblatt - Fiche technique - Data sheet

**21.15.2824**



ROLINE Patchkabel Kat.6A S/FTP (PiMF), Comp. Level, LSOH, gelb, 1,5 m

Cordon ROLINE S/FTP(PiMF) Cat.6A / 10 Gigabit, LSOH, Component Level,  
jaune, 1,5 m

ROLINE S/FTP Patch Cord Cat.6A, Component Level, LSOH, yellow, 1.5 m

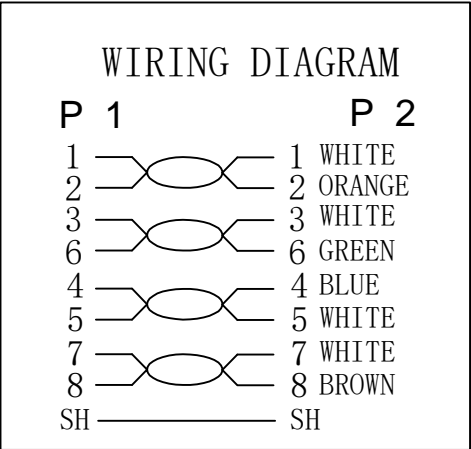
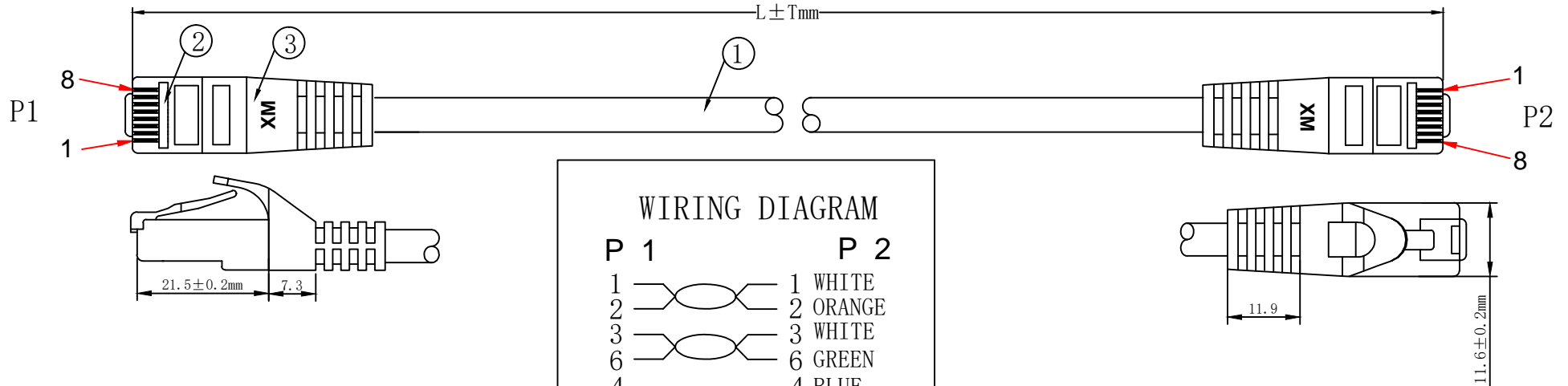

**1. ELECTRICAL TEST:**

- (1).100% OPEN SHORT & MISS WIRE TEST;
- (2). INSULATION RESISTANCE:DC 250V 20M OHM MIN;
- (3). CONTACTOR RESISTANCE:30 OHM MAX

2. PRINTING:GHMT® roline CAT.6A S/FTP COMPONENT PATCH CORD LSZH 500MHZ ISO/IEC 11801 & EN 50173-1 & ANSI/TIA-568-C.2

3.100% Component Patch cord Test PASS

4. Minimum bending radius:60mm

**MATERIAL LIST**

⑥	LABEL	NO DRY GLUE LABEL	1PCS	
⑤	MINI TIE	PE MINI TIE(POSSESS METAL)	2PCS	
④	POLYETHYLENE BAG	POLYETHYLENE BAG	1PCS	
③	OVER MOLD	88A PVC yellow	2PCS	
②	CONNECTOR	RJ45 8P8C'S SHIELDED PIN GOLD PLATED 3u", SHELL PLATED NICKEL Transparent Blue	2PCS	
①	CABLE	S/FTP CAT. 6A 26AWG (BC*1P+AL-FOIL)*4P+BRAID CABLE JACKET LSOH OD=6.2±0.2MM	1PCS	
NO.	PARTS NAME	SPECIFICATION STANDARD	QT' Y	REMARK

COLOUR:yellow (PANTONE:135C)					
ITEM NO.	LENGTH (L)		TOLERANCE (T)		
21. 15. 2972	300mm		± 10mm		
21. 15. 2820	500mm		± 15mm		
21. 15. 2821	1000mm		± 30mm		
21. 15. 2824	1500mm		± 45mm		
21. 15. 2822	2000mm		± 60mm		
21. 15. 2823	3000mm		± 90mm		
21. 15. 2825	5000mm		± 150mm		
21. 15. 2826	7500mm		± 210mm		
21. 15. 2827	10000mm		± 300mm		
21. 15. 2828	15000mm		± 450mm		
21. 15. 2829	20000mm		± 600mm		
ITEM NO.	21. 15. 2972	21. 15. 2820	21. 15. 2821	21. 15. 2822	21. 15. 2823
21. 15. 2824	21. 15. 2825	21. 15. 2826	21. 15. 2827	21. 15. 2828	21. 15. 2829
DESC.	ROLINE S/FTP PatchCord CAT. 6A, LSOH, Comp. Level, yellow				

**SECOMP**

BY	CHK	NEW	2016-09-13	A
		REVISION RECORD MODIFICATIONS	DATE	REV.