



Datenblatt - Fiche technique - Data sheet

**11.99.5575**



VALUE HDMI High Speed Verlängerungskabel, mit Ethernet, Stecker-Buchse,  
2,0m

VALUE Câble HDMI High Speed avec Ethernet M/F, 2,0m

VALUE HDMI High Speed Cable + Ethernet, M/F, 2 m

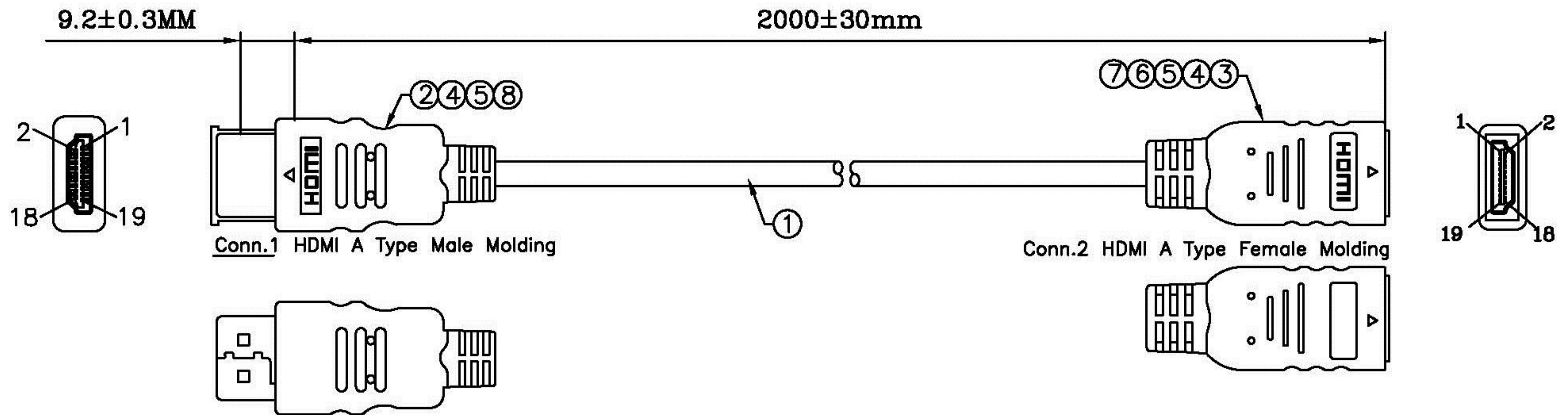

Pin Assignment

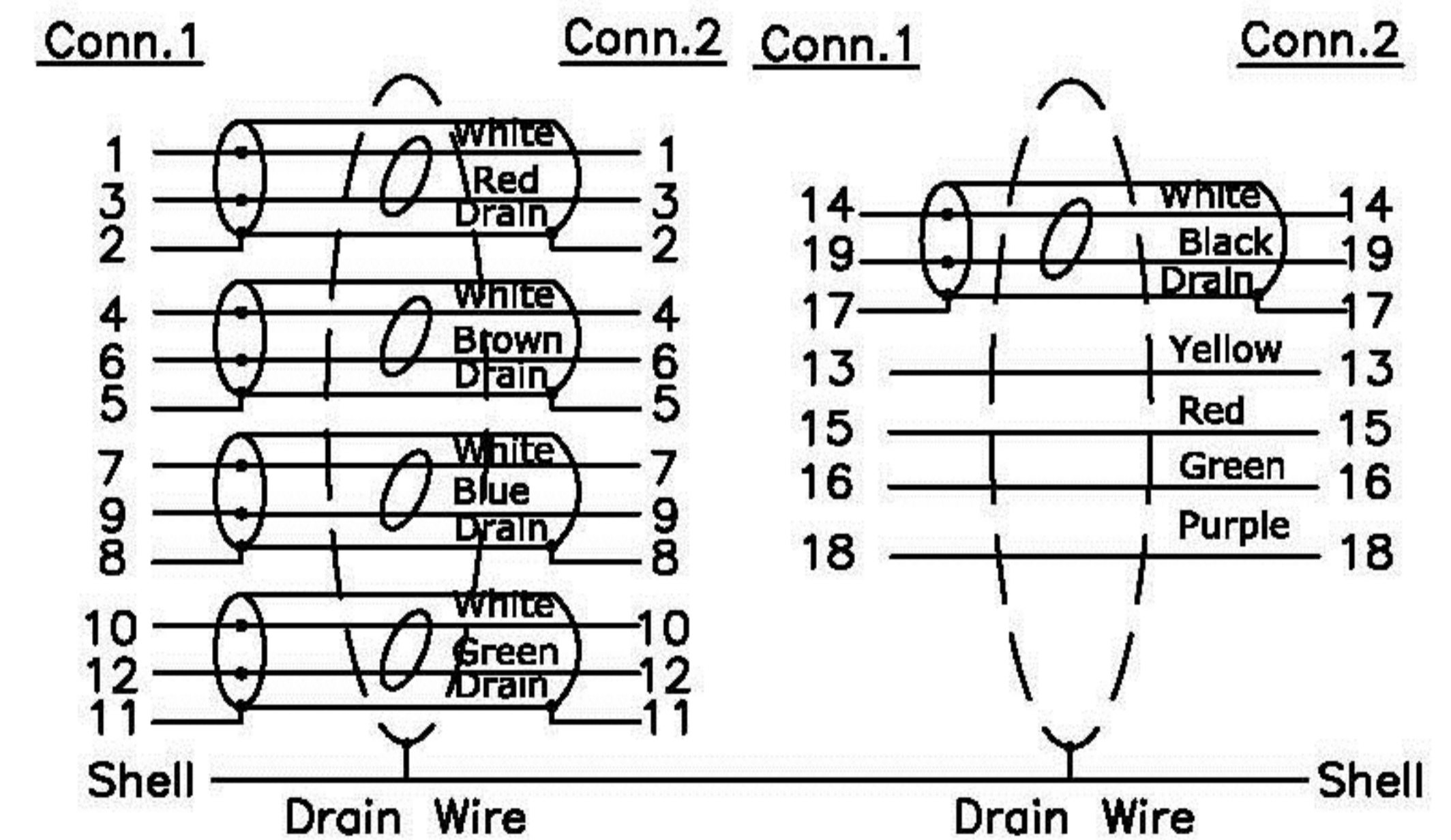

ELECTRICAL TEST:

- 1.100% OPEN & SHORT & MIS WIRE TEST
- 2.CONTACT RESISTANCE:2 OHM(MAX)
- 3.INSULATION RESISTANCE:10M OHM(MIN)
- 4.HI-POT TEST:DC 300V/10ms

8	A6-000015	HDMI M DUST CAP	1	PCS
7	A6-0000146	HDMI F DUST CAP	1	pcs
6	A6-R104248	HDMI F BLACK ABS JACKET	1	pcs
5	A2-R020299	HDMI F 19P w/PCB Solder shell gold plated insulation:black	1	pcs
4	A5-R047001	45P Black PVC	20	g
3	A5-R047011	Transparent PE	6	g
2	A2-R020044	HDMI M 19P Shell gold plated solder insulation:Black	1	pc
1	A4-R001726	High Speed HDMI Cable with Ethernet: UL20276 [30AWG(7/0.102TC) *1PR+DW+AL/MY]*5C+30AWG(7/0.102TC)*4C+AL/MY+DW+Braid(50%AL) +Jacket Color: Black OD:6.0±0.2mm	L	m
NO	ITEM	DESCRIPTION	Q'TY	UNIT

	TOLERANCE		<h1>Rotronic Co., Ltd.</h1>			
	INCHES M/M					
	.X	.015 .30				
.XX	.010 .10	TITLE:		VALUE HDMI High Speed with Ethernet Cable, M/F, 2M		
.XXX	.005 .05	CUSTOMER :				
DRAWN BY	JOE		CUSTOMER P/N :		11.99.5575	
CHECK BY			SCALE	NONE	DRAWING NO.:	REV. A
APPD BY			UNIT	MM		
	DATE	12.05.28	CA1790089		1/1	